



DESIGN SHEET

R-SHADE™

PREMIUM INSULATED PATIO COVER





01 Technical Specs

02 Warranty

03 Color Chart

04 Lighting

05 Sensors



TECHNICAL SPECS



maximum height under beam
post sizes: 141" or 177"



4" above for maintenance

14" x 5 11/16"
double beam + gutter

Recommended
clearance for fire
pits or fans is 10"

22'10" x 22'10"
largest single zone

TECHNICAL SPECS

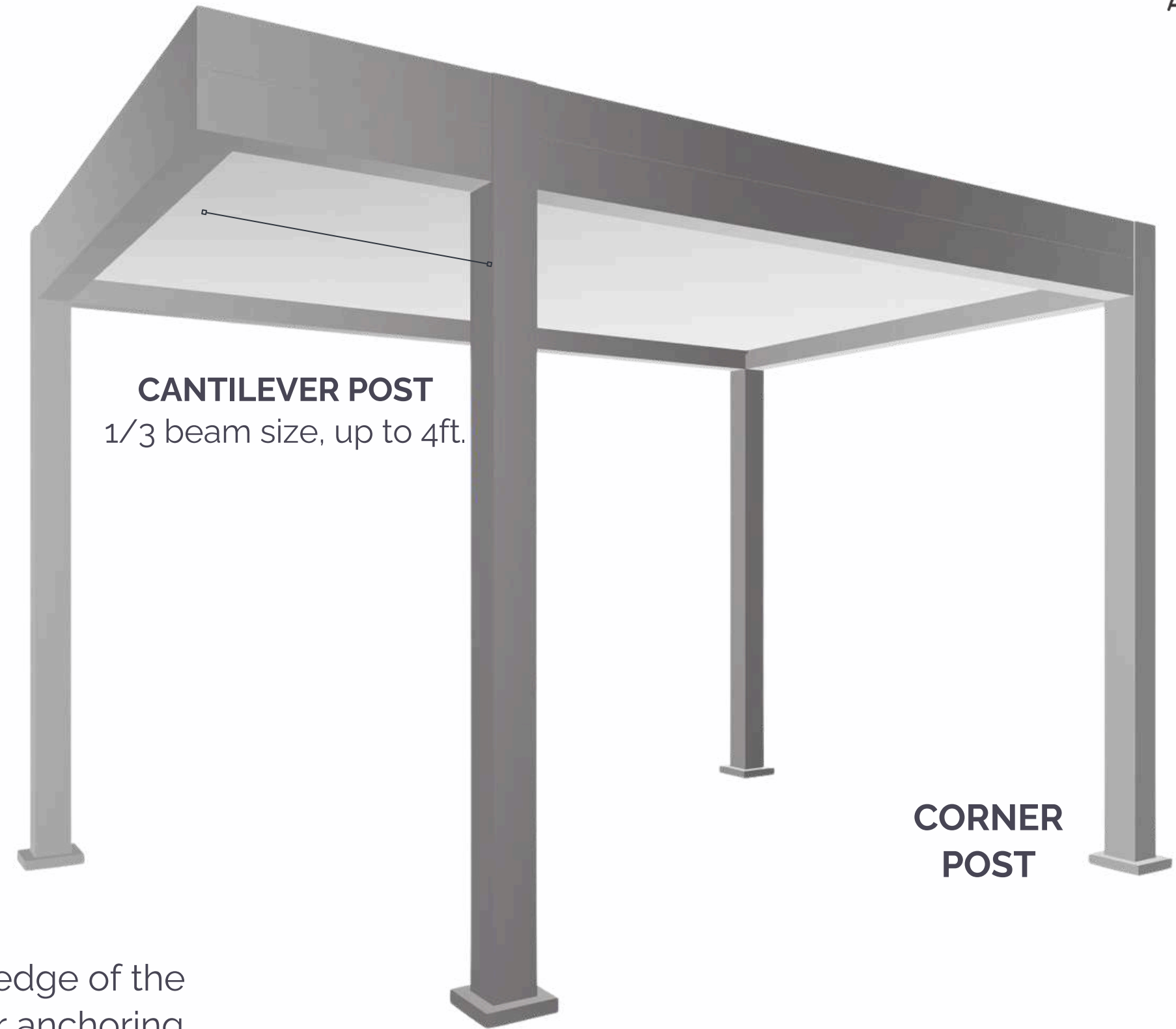
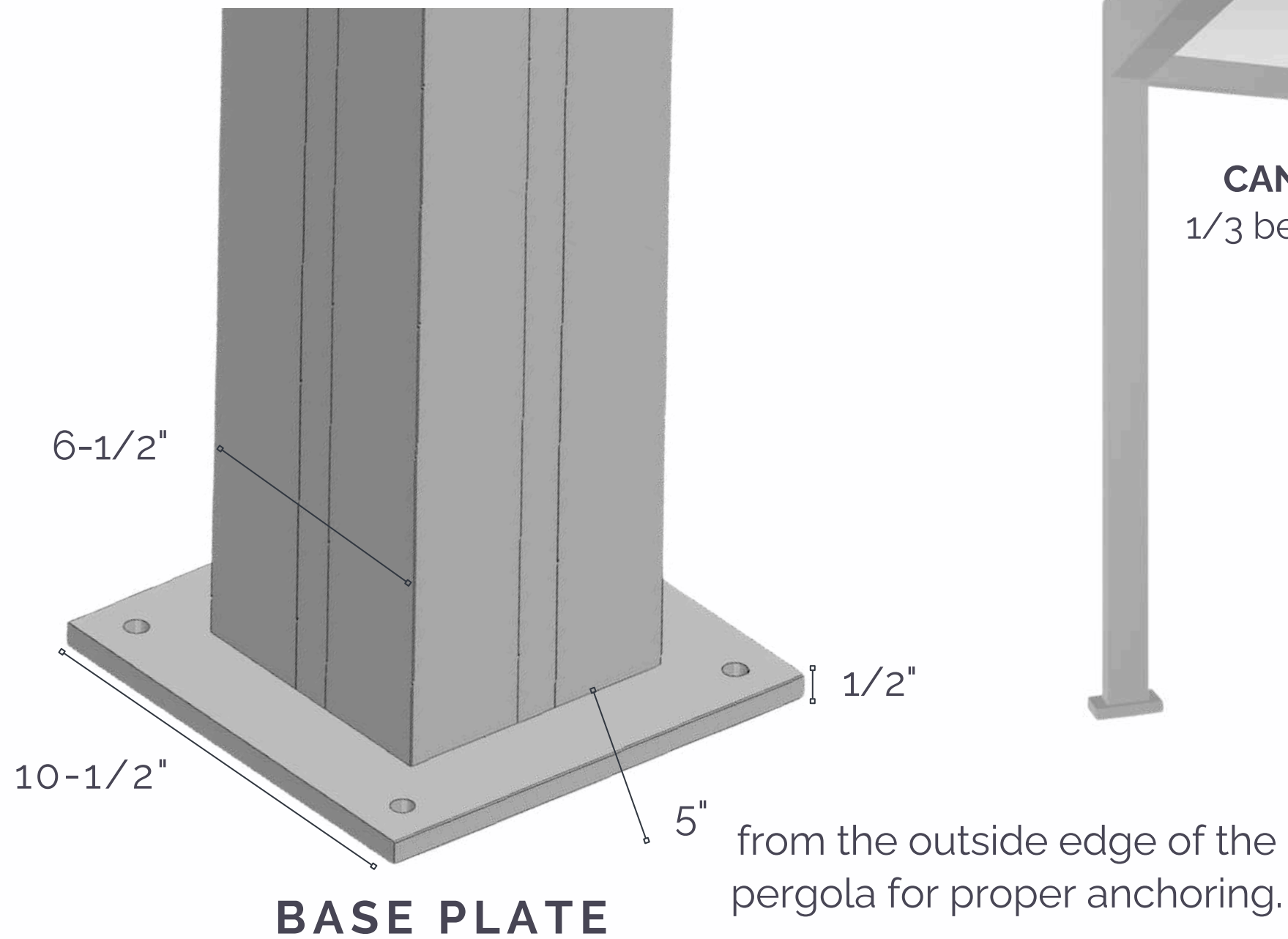

1 TECHNICAL SPECS



2 TYPES OF DRAINAGE

- PVC pipes installed below ground;
- Scuppers placed either in the post or along the gutter.



1/8" pitch toward the drainage posts.

2 scuppers provided per zone



FOR CANTILEVER POST

Scupper required in gutter.

TECHNICAL SPECS



STANDARD PANEL

WHITE OR BRONZE

3" thick | .03" Aluminum sheet

Accessory beam for extra support required when length exceeds **10'** (only in areas with snow & high winds).



UPGRADED PANEL

WOOD GRAIN OR UPGRADED WHITE

3" thick | .03" Aluminum sheet

Leak-proof lock system | No peel-and-seal

Accessory beam for extra support required when length exceeds **15'** (only in areas with snow & high winds).

1 TECHNICAL SPECS

→ weight is in pounds,
frame only.
→ add 43 pounds per post



LENGTH	WIDTH								
ft	8'	10'	11'	13'	15'	17'	18'	20'	22'10"
8'	235 lbs	268 lbs	272 lbs	293 lbs	338 lbs	375 lbs	382 lbs	418 lbs	10645
10'	268 lbs	300 lbs	300 lbs	325 lbs	370 lbs	407 lbs	415 lbs	451 lbs	458 lbs
12'	289 lbs	322 lbs	326 lbs	347 lbs	392 lbs	428 lbs	436 lbs	472 lbs	480 lbs
14'	330 lbs	362 lbs	366 lbs	387 lbs	432 lbs	470 lbs	477 lbs	513 lbs	520 lbs
16'	338 lbs	370 lbs	374 lbs	395 lbs	440 lbs	477 lbs	485 lbs	520 lbs	528 lbs
18'	382 lbs	415 lbs	419 lbs	440 lbs	485 lbs	522 lbs	529 lbs	565 lbs	573 lbs
22'10"	426 lbs	458 lbs	462 lbs	483 lbs	528 lbs	565 lbs	573 lbs	609 lbs	619 lbs

WARRANTY



10 years: against delamination, peeling, cracking, crazing, or blistering

3 years: electronic & electrical components

15 years: aluminum structural components

15 years: standard color powdercoat
10 years: custom color powdercoat



COLOR CHART FRAME

WHITE MAT SMOOTH

SIGNAL WHITE - RAL 9003

AKZONOBEL – YA279QF
CLASS 2 / AAMA 2604

3 to 4 weeks lead time



COLOR CHART FRAME

BRONZE / DARK GRAY TEXTURED

GRIS 2900 SABLE

AKZONOBEL - Y2348QF

CLASS 2 / AAMA 2604

3 to 4 weeks lead time

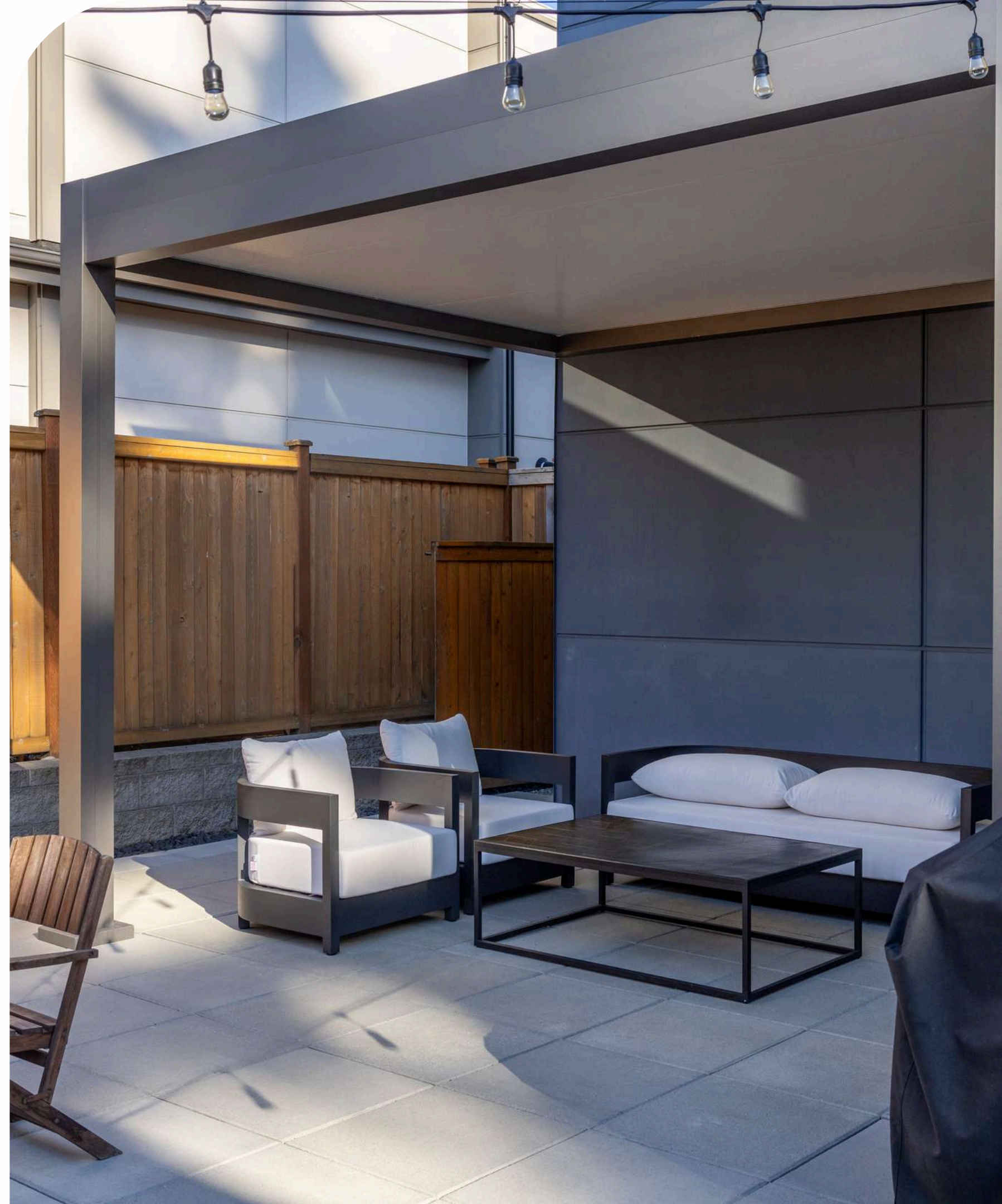

COLOR CHART FRAME

BLACK TEXTURED

EQUINOX BLACK

AKZONOBEL – YN325QF
CLASS 2 / AAMA 2604

3 to 4 weeks lead time



COLOR CHART FRAME

CUSTOM COLOR

- AKZONOBEL COLOR CHART

5 to 12 weeks lead time



COLOR CHART PANELS



Standard White/White



Premium White/White
(extra cost)



Bronze/White

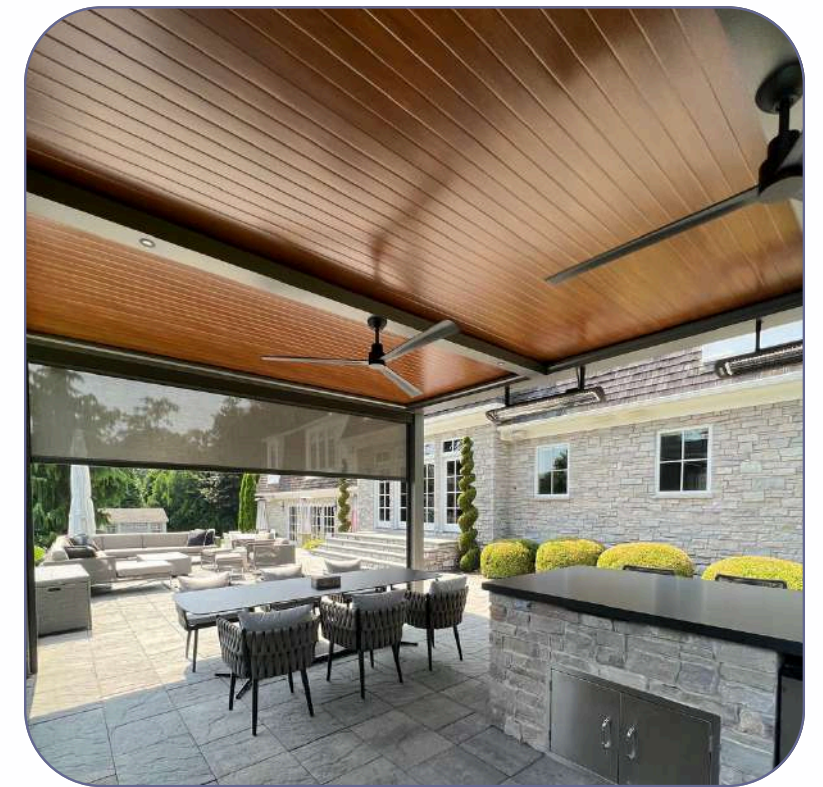

Wood Grain Finish
(extra cost)

LIGHTING

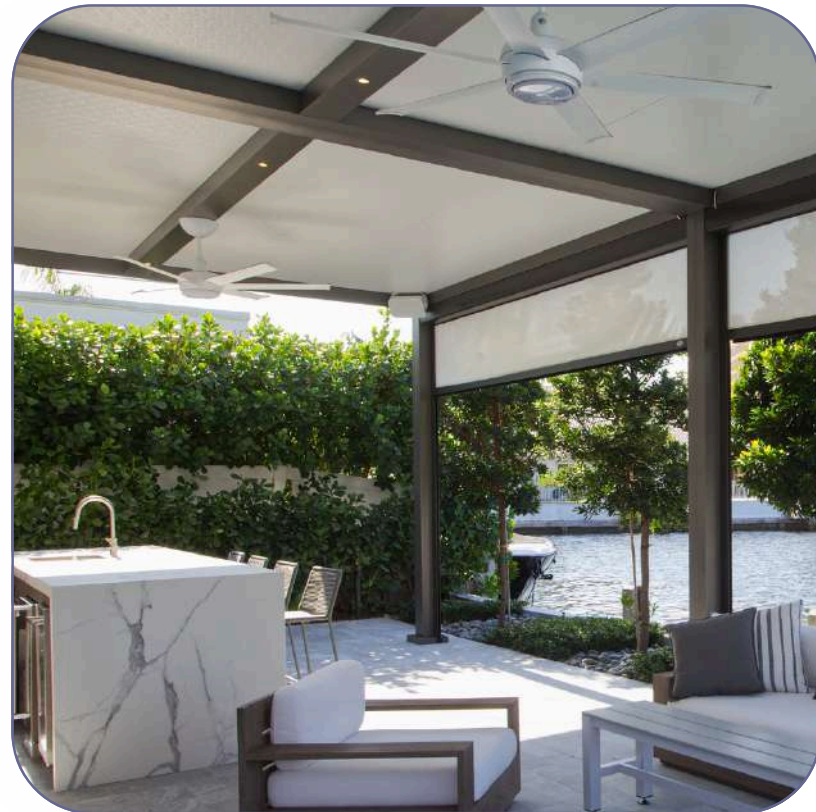

RECESSED LIGHTS

Accessory beam only

DIRECT LIGHTING 4W - 24V - 320 lm

Recommended - 2.5ft intervals, 1ft from frame

Beware of the potential strobing effect when a fan is on.

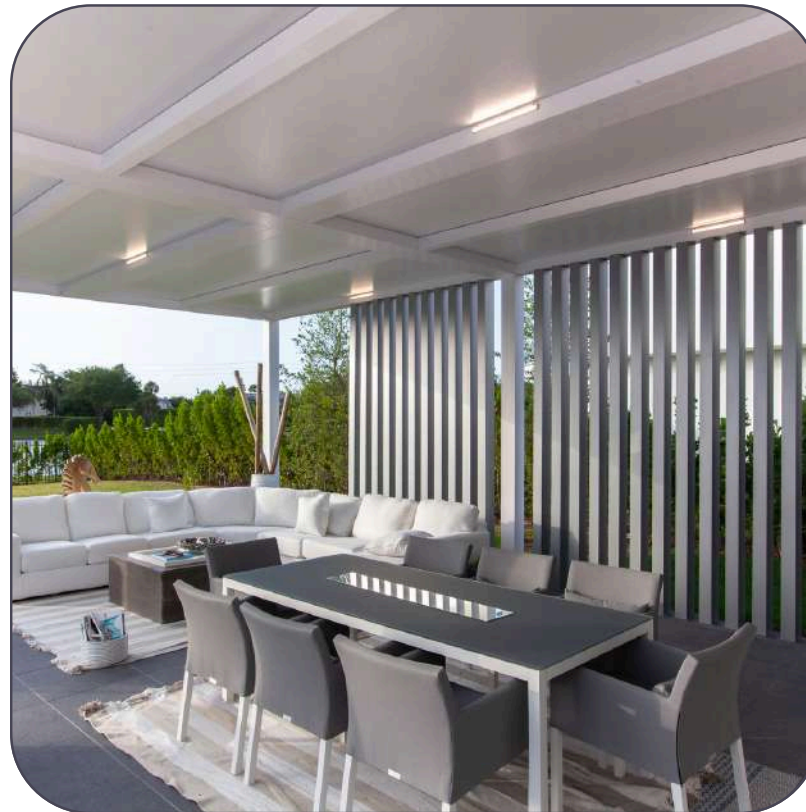

LED RAMPS

Frame and/or Accessory Beam

DIRECT LIGHTING 12W - 24V - 630 lm

Recommended - 3ft intervals, 1ft from frame



LED STRIPS

Frame only

ACCENT LIGHTING 4.5W/ft - 24V - 730 lm

Either on length, width, or the entire frame.

LIGHTING



2700K & dimmable
**controllable with Azenco
 remote & App Control**

LIGHT CONTROL BOX (OPTIONAL)
 20 AMP NEEDED OUTLET

# OF CHANNELS	4 channels			
LIGHTING OPTIONS	Recessed Light	LED Ramp	LED Strip	
MAX PER CHANNEL	6	or	4	or 1
MAX PER CONTROL BOX	30	or	20	or 4

Remember that you can mix and match the lights across different channels to create various configurations within the limits provided.

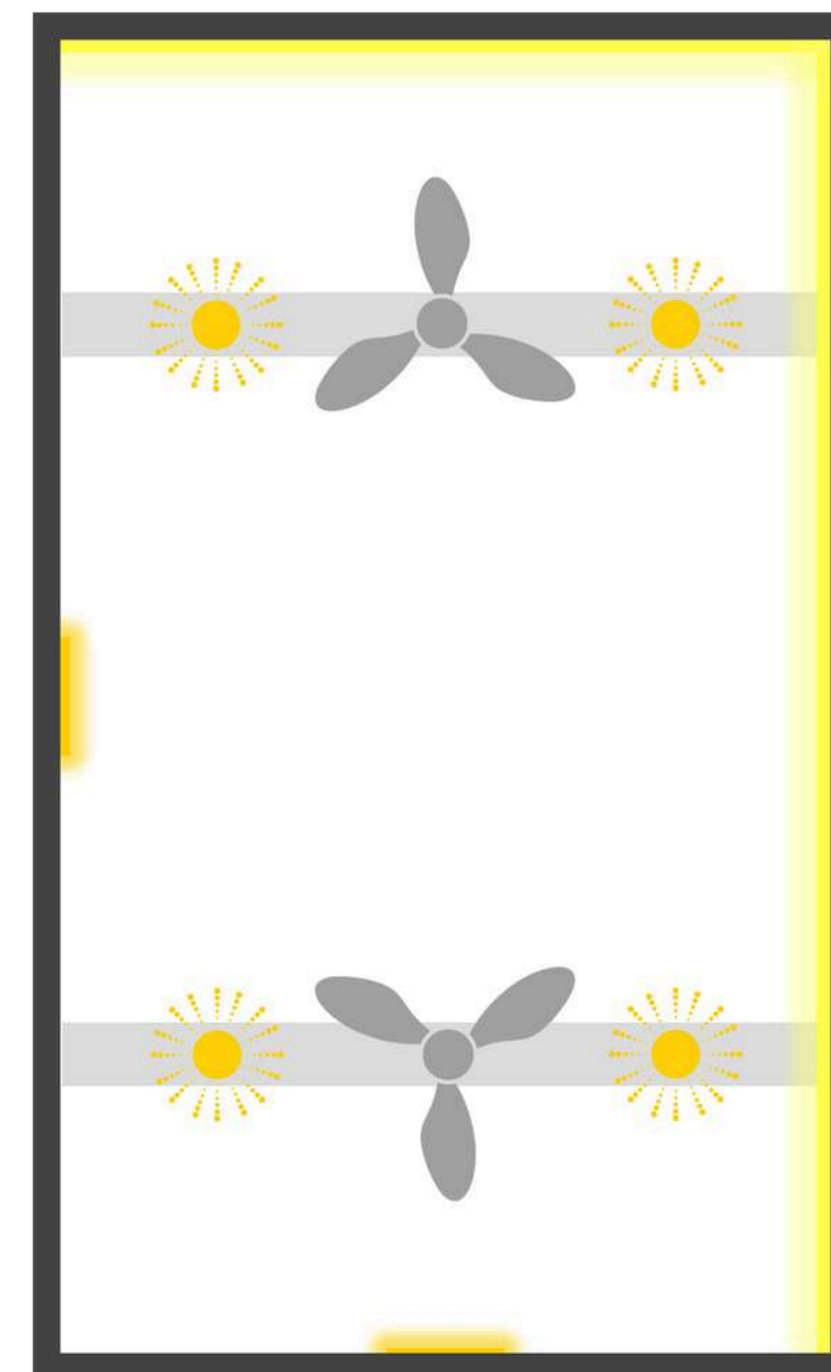



azenco-outdoor.com

(305) 306-3204

azenco@azenco-outdoor.com

725 SE 9th Ct Hialeah, FL 33010